

READY FOR  
WCDMA



## Vector Signal Generator R&S SMIQ

### Digital signals of your choice

- Frequency range 300 kHz to 2.2 GHz/3.3 GHz/4.4 GHz/6.4 GHz
- Analog and digital modulation
- Versatile and broadband generation of digitally modulated signals up to 18 Msymbol/s
- Generation of TDMA, CDMA, WCDMA and CDMA2000 standard signals to all main mobile radio standards
- Broadband I/Q modulator with outstanding vector accuracy
- Optional internal fading simulator to test specifications of mobile radio standards
- Optional internal noise generator and distortion simulator
- Optional BER measurement
- Optional arbitrary waveform generator
- Low ACP for IS-95 CDMA and WCDMA (option)
- Low cost of ownership due to three-year calibration intervals
- Future-oriented platform concept



**ROHDE & SCHWARZ**

The right option for every application

APPLICATION <sup>1)</sup>	R&S SM-B1	R&S SM-B5	R&S SMIQB11 <sup>2)</sup>	R&S SMIQB12	R&S SMIQB14	R&S SMIQB15	R&S SMIQB17	R&S SMIQB20	R&S SMIQB21 <sup>2)</sup>	R&S SMIQB42 <sup>3)</sup>	R&S SMIQB43 <sup>3)</sup>	R&S SMIQB45 <sup>3)</sup>	R&S SMIQB47	R&S SMIQB48	R&S SMIQB60	R&S SMIQB11	R&S SMIQB12
Reference Oscillator OCOXO																	
FM/φM Modulator																	
Data Generator (1.5 Mbit RAM)																	
Memory Extension, 32 Mbit																	
Fading Simulator (6 paths)																	
2nd Fading Simulator (6 paths)																	
Noise Generator and Distortion Simulator																	
Digital Modulation Coder																	
<sup>2)</sup> BER measurement																	
<sup>3)</sup> Digital Standard IS-95 CDMA																	
<sup>3)</sup> Digital Standard WCDMA (NTT DoCoMo 1.0, ARIB 0.0)																	
<sup>3)</sup> Digital Standard WCDMA according to 3GPP (FDD)																	
Low ACP for IS-95 CDMA and WCDMA																	
Extended Functions for WCDMA 3GPP																	
Arbitrary Waveform Generator																	
Digital Standard IS-95 CDMA (with ARB R&S SMIQB60)																	
Digital Standard CDMA-2000 (with ARB R&S SMIQB60)																	
<b>TDMA</b>																	
To standard	<input type="radio"/>	<input type="radio"/>	<input checked="" type="radio"/>	<input type="radio"/>	<input type="radio"/>	<input type="radio"/>	<input type="radio"/>	<input type="radio"/>	<input checked="" type="radio"/>	<input type="radio"/>	<input type="radio"/>	<input type="radio"/>	<input type="radio"/>	<input type="radio"/>	<input type="radio"/>	<input type="radio"/>	<input type="radio"/>
Non-standard	<input type="radio"/>	<input type="radio"/>	<input checked="" type="radio"/>	<input type="radio"/>	<input type="radio"/>	<input type="radio"/>	<input type="radio"/>	<input type="radio"/>	<input checked="" type="radio"/>	<input type="radio"/>	<input type="radio"/>	<input type="radio"/>	<input type="radio"/>	<input type="radio"/>	<input type="radio"/>	<input type="radio"/>	<input type="radio"/>
<b>CDMA IS-95</b>																	
To standard	<input type="radio"/>	<input type="radio"/>	<input checked="" type="radio"/>	<input type="radio"/>	<input type="radio"/>	<input type="radio"/>	<input type="radio"/>	<input checked="" type="radio"/>	<input type="radio"/>	<input checked="" type="radio"/>	<input type="radio"/>	<input type="radio"/>	<input type="radio"/>	<input type="radio"/>	<input type="radio"/>	<input type="radio"/>	<input type="radio"/>
<b>WCDMA</b>																	
To standard	<input type="radio"/>	<input type="radio"/>	<input checked="" type="radio"/>	<input type="radio"/>	<input type="radio"/>	<input type="radio"/>	<input type="radio"/>	<input checked="" type="radio"/>	<input type="radio"/>	<input type="radio"/>	<input checked="" type="radio"/>	<input checked="" type="radio"/>	<input checked="" type="radio"/>	<input type="radio"/>	<input type="radio"/>	<input type="radio"/>	<input type="radio"/>
<b>CDMA 2000</b>																	
To standard	<input type="radio"/>	<input type="radio"/>	<input checked="" type="radio"/>	<input type="radio"/>	<input type="radio"/>	<input type="radio"/>	<input type="radio"/>	<input checked="" type="radio"/>	<input type="radio"/>	<input type="radio"/>	<input type="radio"/>	<input type="radio"/>	<input type="radio"/>	<input type="radio"/>	<input type="radio"/>	<input checked="" type="radio"/>	<input checked="" type="radio"/>
<b>Fading</b>																	
	<input type="radio"/>	<input type="radio"/>	<input type="radio"/>	<input type="radio"/>	<input type="radio"/>	<input checked="" type="radio"/>	<input type="radio"/>	<input type="radio"/>	<input type="radio"/>	<input type="radio"/>	<input type="radio"/>	<input type="radio"/>	<input type="radio"/>	<input type="radio"/>	<input type="radio"/>	<input type="radio"/>	<input type="radio"/>
<b>Vector modulation</b>																	
	<input type="radio"/>	<input type="radio"/>	<input type="radio"/>	<input type="radio"/>	<input type="radio"/>	<input type="radio"/>	<input type="radio"/>	<input type="radio"/>	<input type="radio"/>	<input type="radio"/>	<input type="radio"/>	<input type="radio"/>	<input type="radio"/>	<input type="radio"/>	<input type="radio"/>	<input type="radio"/>	<input type="radio"/>
<b>Analog modulation (AM, FM, φM)</b>																	
	<input type="radio"/>	<input checked="" type="radio"/>	<input type="radio"/>	<input type="radio"/>	<input type="radio"/>	<input type="radio"/>	<input type="radio"/>	<input type="radio"/>	<input type="radio"/>	<input type="radio"/>	<input type="radio"/>	<input type="radio"/>	<input type="radio"/>	<input type="radio"/>	<input type="radio"/>	<input type="radio"/>	<input type="radio"/>
<b>Fast setting time</b>																	
	<input type="radio"/>	<input type="radio"/>	<input type="radio"/>	<input type="radio"/>	<input type="radio"/>	<input type="radio"/>	<input type="radio"/>	<input type="radio"/>	<input type="radio"/>	<input type="radio"/>	<input type="radio"/>	<input type="radio"/>	<input type="radio"/>	<input type="radio"/>	<input type="radio"/>	<input type="radio"/>	<input type="radio"/>

1) R&S SMIQ02B/03B (R&S SMIQ04B/06B) can be equipped with up to three (two) of the following options: R&S SM-B5, R&S SMIQB14, R&S SMIQB15 or R&S SMIQB17  
 2) Option R&S SMIQB20 required  
 3) Options R&S SMIQB20 and R&S SMIQB11 required  
 ● = required      ○ = optional

R&S SMIQ rear panel



## A safe investment for the future ...

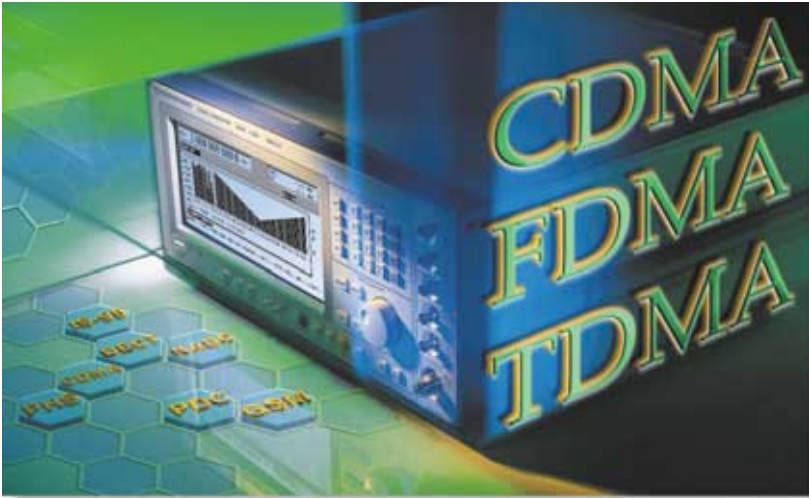

The B series of Signal Generator Family R&S SMIQ for analog and digital modulation from Rohde&Schwarz is offering solutions for today and tomorrow. This series particularly takes into account future developments in the field of 3rd-generation digital mobile radio.

The R&S SMIQ family comprises four models which differ in their upper frequency limits. These feature a hitherto unrivalled versatility regarding signal

The wide frequency range from 300 kHz to 6.4 GHz covers all main radio bands including their IF ranges.

The high-grade I/Q modulator fitted as standard ensures minimum error vector magnitude and high intermodulation suppression.

Using modern digital signal processor (DSP) technology, the versatile concept allows the generation of high-precision digital modulation signals with high bit rates without any limitations on modulation modes or standards.

SMIQ02B*)	300 kHz to 2.2 GHz
SMIQ03B*)	300 kHz to 3.3 GHz
SMIQ04B*)	300 kHz to 4.4 GHz
SMIQ06B	300 kHz to 6.4 GHz

generation and signal quality and are therefore ideal for use in development and type-approval testing.

With their outstanding price/performance ratio, these signal generators are also economically attractive for applications in production.

In addition to digital modulation, the signal generators provide the full range of analog modulation modes as well as simultaneous modulation capability.

\*) Every model upgradable up to 6.4 GHz

# R&S SMIQ – a signal generator family ...

## Digital modulation

### Any digital modulation modes (with option R&S SMIQB20)

- Free choice of modulation mode from ASK through to 256QAM
- Any kind of baseband filtering with variable filter parameters
- Symbol rate adjustable up to 18 Msymbol/s
- Realtime coding of internal and external data
- Internal PRBS generators

### Convenient burst generation for TDMA standards (with option R&S SMIQB20/ R&S SMIQB11)

- TDMA mobile radio standards provided as standard GSM, GSM-EDGE, DECT, NADC (IS-54C/IS-136), PDC, PHS
- Versatile external synchronization capabilities
- Realtime processing of external and internal data

- Generation of TDMA frames with versatile timeslot configuration
- Continuous PRBS sequences
- Optimization of burst shaping to reduce spectra due to switching
- Realtime processing with external data for BER tests
- Slot-by-slot modulation change for TDMA
- Signals with preprogrammed frame structure

### Up to 79 Mbit internal data memory (with 2 x option R&S SMIQB12)

### Optional multichannel WCDMA signals for 3GPP (FDD) systems (R&S SMIQB45)

### Optional cdma2000 standard (R&S SMIQB60 + R&S SMIQK12)

### Optional WCDMA standard to ARIB0.0 standard and NTT DoCoMo 1.0 (R&S SMIQB43)

### Optional CDMA standard to IS-95 (R&S SMIQB42 or R&S SMIQB60 + R&S SMIQK11)

## Special options

### Fading simulation (options R&S SMIQB14 and R&S SMIQB15)

- Fading of internal or external I/Q signals conforming to mobile radio standards
- 6-path simulation can be enhanced to 12-path simulation (2-channel fading also possible with second vector signal generator)
- Selectable path attenuation and delay
- Simulation of high speeds
- Preprogrammed fading profiles for mobile radio standards GSM, NADC, IS-95 CDMA and TETRA

## Analog modulation

- Broadband AM with up to 30 MHz modulation frequency
- I/Q modulation with 30 MHz modulation bandwidth (3 dB), 60 MHz RF bandwidth
- Unprecedented vector accuracy and high intermodulation suppression
- Amplitude modulation
- Pulse modulation
- Optional frequency and phase modulation (R&S SM-B5)

## RF characteristics

- Wide output frequency range from 300 kHz to 6.4 GHz
- High (up to 16 dBm) and precise output level (<0.5 dB)
- Fast setting time for frequency (<3 ms) and level (<2.5 ms) \*
- Frequency hopping (500 μs)
- High spectral purity (typ. -130 dBc (1 Hz) at 1 GHz and 20 kHz carrier offset)
- RF, AF and level sweep (user-programmable)

\*) Without switching the mechanical attenuators

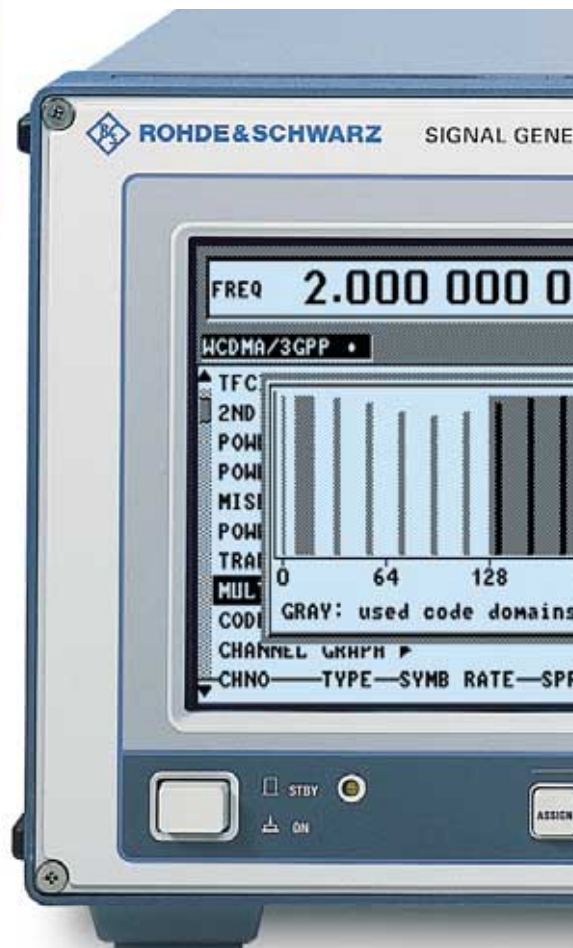

# ... for all requirements

- Frequency range of basic unit can be fully utilized
- Calibrated RF level in range from -140 dBm to -5 dBm
- Unrivalled price/performance ratio

### Noise generator and distortion simulator (option R&S SMIQB17)

- Simulation of amplitude and phase distortion (AM/AM and AM/φM characteristics)
- Distortion characteristics programmable from up to 30 input values

- Superimposed noise signals (AWGN)
- C/N ratio variable with high resolution over a wide range
- Broad noise bandwidth (10 kHz to 10 MHz)

### Bit error rate measurements (option R&S SMIQB21)

- Up to 30 MHz clock rate

### Low ACP for IS-95 CDMA and WCDMA (option R&S SMIQB47)

- Specially designed for 1.2288 Mcps

- (cdmaOne/cdma2000), 3.84 Mcps and 2 channels
- 3.84 Mcps/5 MHz offset (3GPP)
- Can be used with internal (option R&S SMIQB42/43/45) or external CDMA/WCDMA signals
- Typical WCDMA adjacent-channel power ratio (5 MHz offset, 3.84 Mcps): -67 dBc (1 DPCH)
- Typical IS-95 CDMA adjacent-channel power ratio (885 kHz offset): -78 dBc (9 code channels)

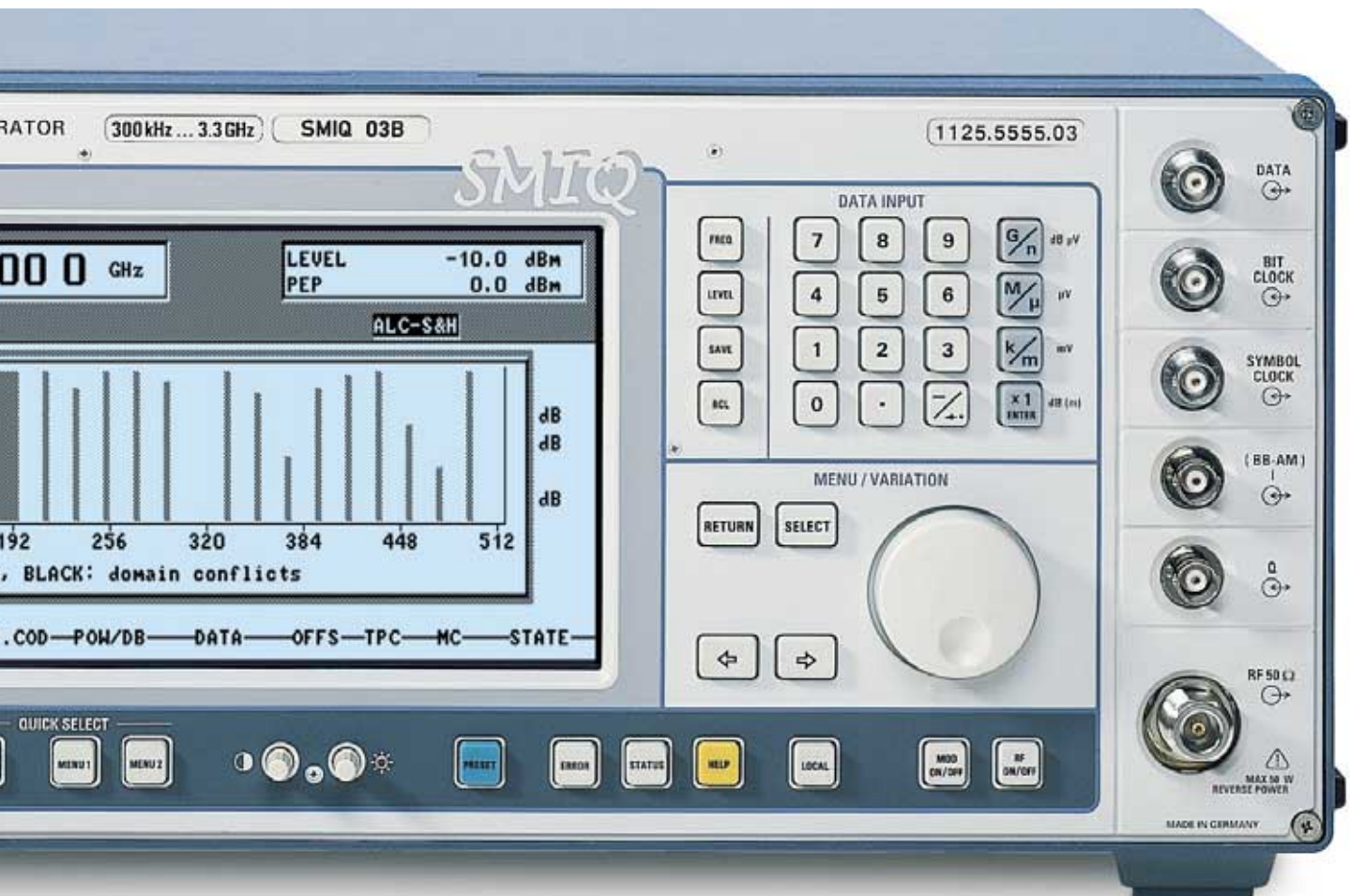

# Outstanding RF characteristics

## From 300 kHz to 6.4 GHz

With its wide frequency range, the R&S SMIQ family has the right model for every application. The uppermost frequency limit of 6.4 GHz leaves sufficient margin even for WLL (wireless local loop) systems. Frequency extension options allow upgrading to higher frequency limits.

## Level – high and precise

With a maximum output level of +13 dBm (+16 dBm in overrange) insertion losses caused by cables or switching matrixes can easily be compensated. For driving components with high input level the use of an external amplifier is not necessary.

A level accuracy of <0.5 dB allows high-precision measurements even on highly sensitive analog and digital receivers.

## Excellent spectral purity

R&S SMIQ provides output signals of excellent spectral purity. Low-noise frequency synthesis ensures modulation of highest quality for reliable test signals.

## Fast setting times

Fast setting times are among the most important criteria when it comes to choosing the right signal generator, especially in production.

The synthesizers of the R&S SMIQ family excel in this respect: with a frequency setting time of less than 3 ms they allow extremely fast measurements.

Besides standard sweep functions for RF, AF and level, R&S SMIQ features an extremely versatile and fast sweep mode for frequency and level settings to be carried out with the aid of stored lists. This mode with a setting time of less than 500  $\mu$ s is ideal for frequency hopping applications.

## Low cost of ownership

The use of high-precision reference elements with long-term stability ensures reliable operation over a long period of time. The three-year calibration intervals cut costs and increase availability.

## Designed for the future

The open concept of R&S SMIQ allows the functionality of the signal generator to be adapted to future requirements in a simple and cost-effective way.

Since R&S SMIQ uses programmable digital signal processing chips throughout, its capabilities are not limited by the hardware used.

New functions can be downloaded very simply via the serial interface of the generators.

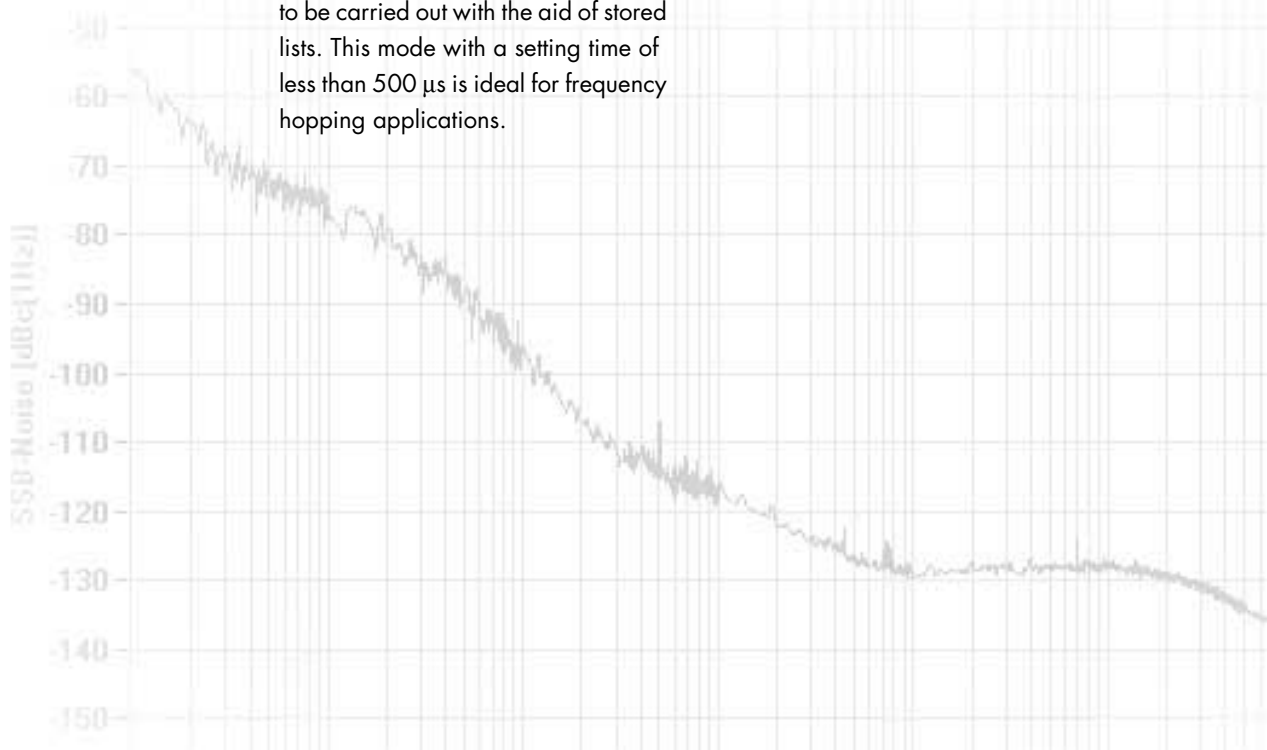

Typical level accuracy at 0 dBm

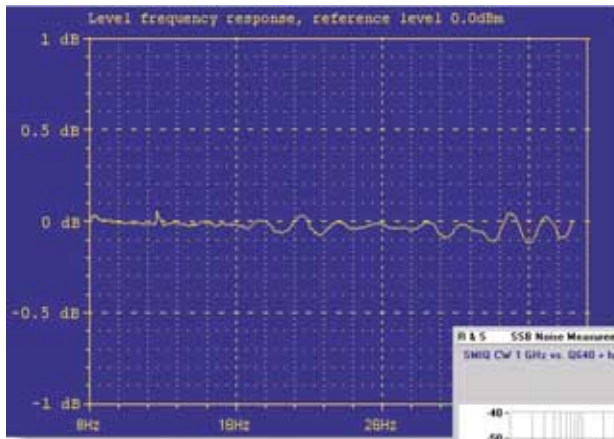

Typical I/Q frequency response

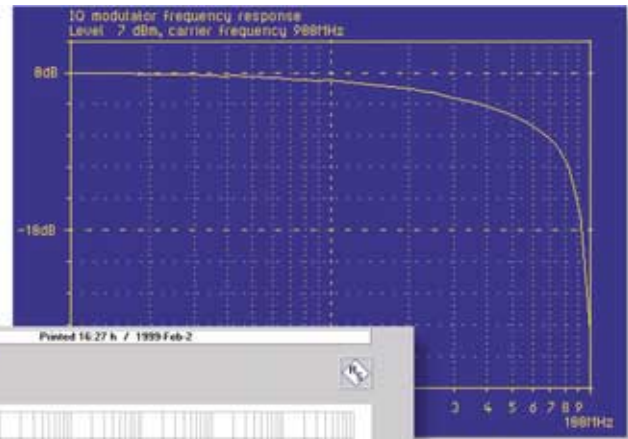
Typical SSB phase noise at  $f_c=1$  GHz

## Analog modulation

### Excellent analog characteristics

R&S SMIQ sets standards in the field of digital modulation – without any restrictions on the analog side.

#### Amplitude modulation

The modulation frequency range is DC to 50 kHz. Particularly noteworthy is the extremely low incidental phase modulation with AM, which plays an important role in AM sensitivity tests on FM receivers.

#### Frequency modulation (option R&S SM-B5)

The modulation frequency range is DC to 2 MHz. In the FM DC mode, extremely high carrier frequency accuracy is ensured through the use of a nov-

el control circuit. There is virtually no drift. This characteristic allows the digital signalling of receivers also by means of analog frequency modulation.

#### Phase modulation

Phase modulation ranges from DC to 100 kHz. This wide span opens up fields of application for which most signal generators do not qualify, for instance tests on phase-sensitive circuits or the generation of PSK modulation with freely selectable phase deviation.

#### IQ modulation at the highest level

The precision I/Q modulator of R&S SMIQ is the basis for the excellent modulation characteristics with spurious suppression of more than 70 dB.

In addition to a bandwidth that is designed for the needs of future broadband systems, the modulator features high intermodulation suppression which with digital modulation yields excellent characteristics regarding adjacent-channel power.

#### Broadband amplitude modulation

Broadband amplitude modulation (BB-AM) is provided as standard and allows accurate envelope control (eg for pulse shaping) or generation of analog video signals. It features high modulation quality and low incidental FM at modulation frequencies of up to 30 MHz (3 dB) and is generated via the I input of the I/Q modulator.

# Digital modulation

## Fit for every requirement

The rapidly changing digital communications market makes great demands on measurement technology: for one thing measurements need to be done fast in an uncomplicated way, for another investments made today should cover the requirements of tomorrow. R&S SMIQ is setting standards. It provides convenient generation of high-precision signals in line with today's digital standards and in addition allows free variation of all digital modulation parameters.

## TDMA, CDMA or WCDMA?

R&S SMIQ is at home in all access methods. It is just as good in generating versatile frame structures of all main TDMA systems as it is in CDMA and WCDMA applications.

## Universal modulation coder

The universal modulation coder (option R&S SMIQB20) is the core of complex digital modulation generation. From the digital input signals it derives the analog signals for the I/Q modulator of R&S SMIQ in realtime. The internal or external digital input signals are made up of serial or parallel data bit streams, clock signals, signals for burst control and triggering. A PRBS generator of different sequence lengths is contained in the modulation coder as an internal signal source.

The modulation coder allows free selection of the format, baseband filtering and symbol rate of digital modulation. The selected parameters can be varied within a wide range.

## Four ways of generating digital signals

Vector Signal Generators R&S SMIQ can generate digitally modulated signals in four different ways.

### 1. Vector modulation

In this mode, externally generated I/Q signals are applied to the I/Q modulator of R&S SMIQ. I/Q Modulation Generator R&S AMIQ together with Simulation Software R&S WinIQSIM™ are perfect tools for the generation of external I/Q signals.

### 2. Digital modulation

The universal modulation coder (R&S SMIQB20) and data generator (R&S SMIQB11) options provide a platform for generating digitally modulated signals that are variable in a wide range. Modulation mode, filtering, data source and symbol rate can be selected by the user.

### 3. Digital standards

The digital standards provide at a keystroke base-station and mobile-station signals to telecommunication standards – based on the capabilities of the optional digital modulation coder (R&S SMIQB20). The TDMA (time division multiple access) standards GSM, GSM-EDGE, DECT, NADC (IS-54C, IS-136), PDC and PHS come with the optional data generator (R&S SMIQB11). The CDMA standard IS-95 (R&S SMIQB42) or WCDMA according to NTT DoCoMo systems (R&S SMIQB43) as well as WCDMA according to 3GPP/FDD (R&S SMIQB45) are also available as an option. The number of future digital standards that can be simultaneously accommodated in R&S SMIQ is unlimited.

### 4. Arbitrary waveform generator

The arbitrary waveform generator (option R&S SMIQB60) is an integrated I/Q modulation source adding extra functionality to R&S SMIQ. It allows the generation of **arbitrary** modulation signals such as COFDM, multicarrier, or noise. The most convenient way of generating a wide variety of signals is by computing them with the supplied R&S WinIQSIM™ PC software and loading them into the unit (see data sheet PD 0757.3970). Signals computed with the aid of commercial mathematical programs can be transferred, too, using free-of-charge auxiliary software (R&S IQWizard).



## Comprehensive synchronization capabilities

The optional Data Generator R&S SMIQB11 with a memory of 15 Mbit, which can be extended up to 79 Mbit, is the internal data source for the modulation coder. These data are also available at the outputs, eg as reference for BER (bit error rate) measurements.

Up to six different control signals can be generated synchronously with the data bits to provide symbol-accurate trigger signals, control frequency hopping and mark level bursts. With the aid of these control signals external measurements can be synchronized.

The internally generated data streams of the data generator can conveniently be synchronized to external trigger events. A comprehensive range of functions such as trigger delay is available for this purpose. The switching threshold of the trigger input can be adjusted to the level of external signals.

## Convenient burst signal generation

Symbol-synchronous amplitude control of the RF signal is required especially for generating test signals for mobile radio systems using a TDMA method.

In addition to ensuring a large dynamic range, the switching of timeslots should be such that the spectrum due to switching is suppressed to a very high degree.

R&S SMIQ is ideal to meet these requirements. Convenient menus allow timeslots to be defined independently of one another, reduced in level or completely switched off. Moreover, the slew rate and the shape of the switching signal edge can be varied.



... fit already today for tomorrow's communication

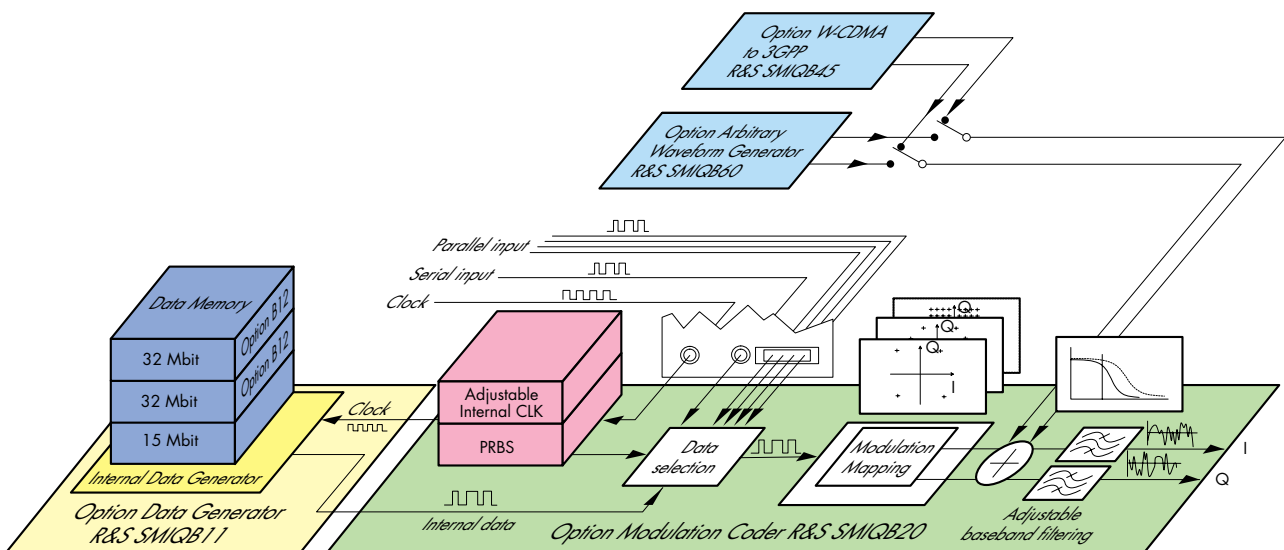

Principle of digital modulation signal generation

# Digital modulation

## Standards

R&S SMIQ fitted with the two options modulation coder (R&S SMIQB20) and data generator (R&S SMIQB11) provides standard-conformal signals for testing mobile and base stations of the main mobile radio networks. These test signals contain the necessary protocol information and frame structures for testing receivers.

The timeslots (bursts) and their data contents can be specified for the TDMA standards GSM, GSM-EDGE, DECT, NADC, PDC and PHS via user-friendly menus. The main burst types are predefined and available at a key-stroke. They can easily be modified, stored and reused for tests.

Continuous PRBS data streams and internally generated data lists as well as externally provided serial data streams can be inserted in realtime into the data fields of the frame structures.

### GSM Global System for Mobile Communication

Frames and timeslot configuration conform to the GSM standard. Each timeslot (burst) has a certain data structure depending on its use, eg as traffic channel or channel for frequency synchronization.

### GSM-EDGE System for Mobile Communication

In comparison with GSM and GMSK modulation GSM-EDGE is based on 8PSK with  $3\pi/8$  rotated modulation. Modulation change between GMSK and 8PSK is possible slot by slot.

GSM spectrum

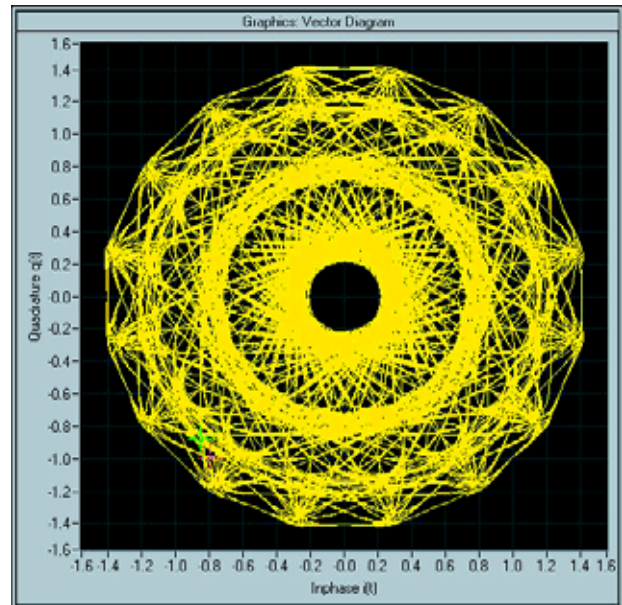
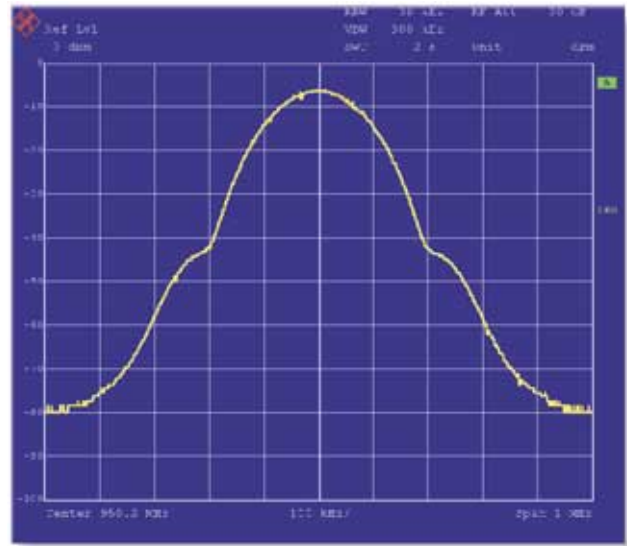

EDGE vector diagram

### DECT Digital Enhanced Cordless Telecommunication Standard

This operating mode allows signals to be generated to ETSI DECT standard.

### NADC North American Digital Cellular (IS-54C, IS-136)

The data protocol structure conforms to NADC specifications IS-54C and IS-136. The following predefined burst types are available: uplink burst, downlink burst, all data.

## PDC Personal Digital Cellular (RCR STD-27C)

The data protocol structure conforms to PDC specification RCR-27C. This standard is largely identical with the NADC standard.

## PHS Personal Handy Phone System (RCR STD-28)

The data protocol structure conforms to PHS specification RCR-28. The following predefined burst types are provided: control physical slot, communication physical slot, sync, TCH, VOX, all data.

## CDMA IS-95 Code Division Multiple Access (with option R&S SMIQB42)

For the CDMA base-station signal (forward link) up to 64 code channels can be generated with user-selected Walsh codes. The power of the code channels can be selected independently for up to four channels. The channel data consist of various internal PRBS or fixed data patterns.

The mobile-station signal (reverse link) can be configured for full-rate as well as for half-rate operation. Moreover it is possible to generate a channel-coded reverse-link signal.

## WCDMA to NTT DoCoMo and ARIB (with option R&S SMIQB43)

WCDMA is one of the favoured technologies for 3rd generation mobile radio.

Fitted with option WCDMA (R&S SMIQB43), R&S SMIQ is able to generate WCDMA signals to the Japanese specifications of NTT DoCoMo and ARIB<sup>1)</sup>.

<sup>1)</sup> Association of Radio Industries and Businesses (ARIB), Specifications of Air Interface for a 3 G Mobile System

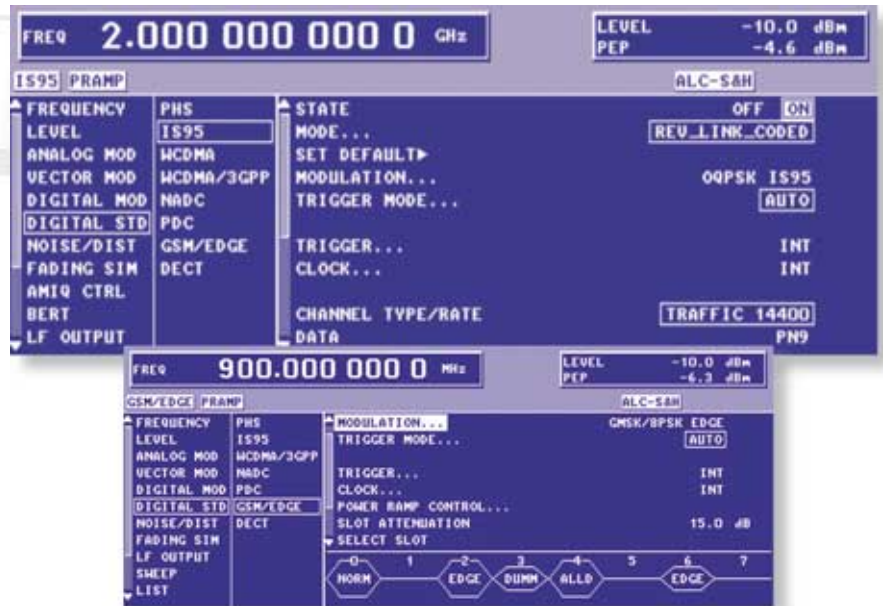

Like with IS-95 CDMA, uplink (mobile station to base station) and downlink (base station to mobile station) can be simulated with up to 15 code channels. A chip rate of 4.096 Mcps is preset, but can be varied any time.

There is a choice of different types of physical channels, such as perch, common control or dedicated physical channels. The frame structure consisting of various data fields (traffic power control or long code mask symbol) is automatically generated for each type of channel.

## WCDMA to 3GPP/FDD (with option R&S SMIQB45)

Software option R&S SMIQB45 supports the generation of downlink and uplink signals in line with the 3GPP standard (FDD mode). As the standardization process is not yet completed, the functionality of this option will continuously be adapted to the relevant standard modifications and expansions (for functionality see specifications).

The physical channels including their slot structure are simulated as a whole. Therefore the signals exactly conform to the 3GPP standard regarding timing, spectral distribution and amplitude probability distribution and thus allow correct measurements on the components to be tested.

# Digital modulation

Signals can be configured in many different ways:

- The current 3GPP standard is supported, stipulating a chip rate of 3.84 Mcps and 15 slots/frame.
- Up to four base or mobile stations with separately selected scrambling code can be simulated. One BS may have up to 128 data channels in addition to special channels. An MS can be operated in the three modes PRACH only, PCPCH only and DPCCH + DPDCH (max. 6 DPDCHs).
- Symbol rate, channelization code, power (can even be varied in time) as well as data contents and timing offset can be selected for each code channel (timing offset can be used to influence signal statistics and thus crest factor).
- P-/S-CPICH, P-/S-SCH, P-/S-CCPCH, AP-/CD-AICH, PDSCH, DL-DPCCH and DPCHs with their corresponding slot structure can be generated in the downlink.
- Transmit diversity is also already supported.
- The clipping function allows simple simulation of the clipping measures implemented in every base station.
- With the R&S SMIQ firmware version 5.70 or higher, WCDMA 3GPP (FDD) signals are generated to 3GPP version 4.1.0. For the downlink, test models 1 (with 16/32/64 channels), 2, 3 (16/32 channels) and 4 have been implemented (to TS25.141). This enables the user to activate downlink test signals to 3GPP specification with a keystroke. There are two non-standardized test scenarios available for the uplink (DPCCH + 1 DPDCH at 60 ksps and DPCCH + 1 DPDCH at 960 ksps).

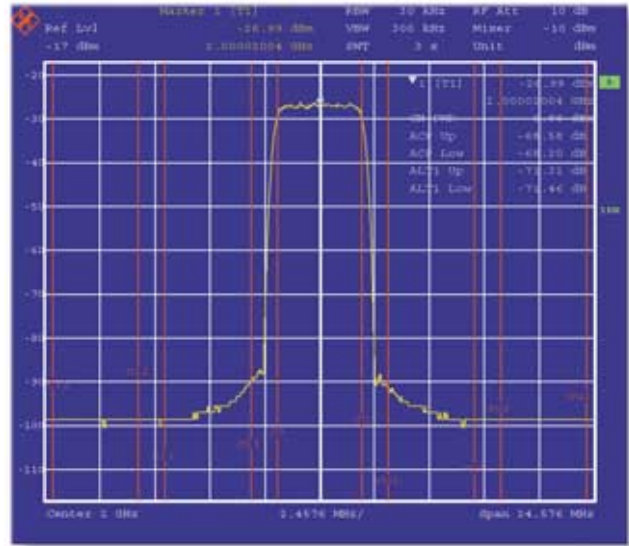

WCDMA spectrum

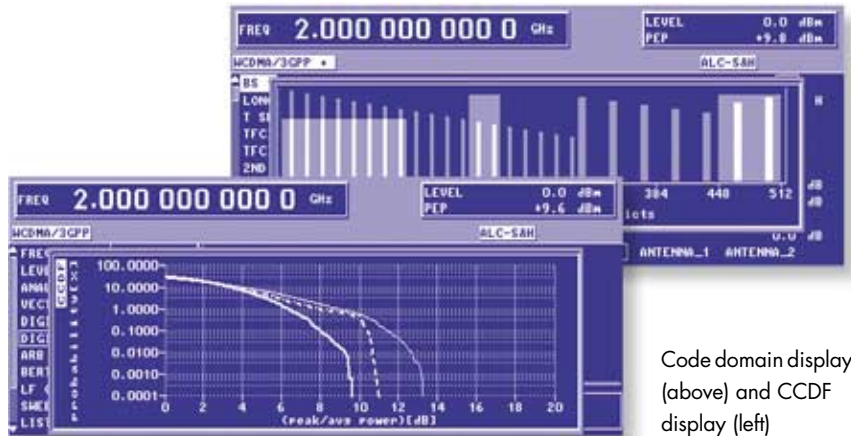

Code domain display (above) and CCDF display (left)

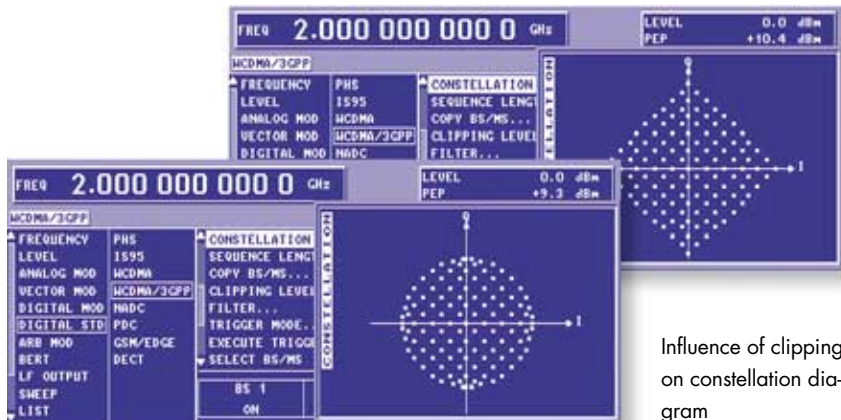

Influence of clipping on constellation diagram

- The long signal length of up to 13 frames (with 3.84 Mcps) allows realistic signals to be generated.

Despite the large variety of functions provided by this option, WCDMA signals can quickly be generated with the aid of assistant functions. With the aid of predefined settings which may additionally be varied through the selection of the crest factor and the number of data channels a WCDMA signal can be generated with a few keystrokes. Further editing tools allow simultaneous configuration of numerous data channels and copying of a complete BS or MS configuration.

But there is much more. R&S SMIQ also provides numerous tools for checking the selected settings: overlapping of individual code channels in the code domain (domain conflicts) is displayed and can automatically be resolved by a key-stroke. The graphic display of constellation diagram, CCDF, occupied code domain and active channels allows the generated signals to be checked for conformance to expectations even without the use of an analyzer.

### Enhanced functions for WCDMA 3GPP (FDD) digital standard with option R&S SMIQB48

This option expands the functionality of option R&S SMIQB45 WCDMA

Display of power control graph with external power control



3GPP. It allows the generation of up to four enhanced channels that can be combined with the standard channels.

This opens up a variety of other applications:

- The maximum sequence length of four enhanced channels is 256 frames. If only one channel is required, the maximum is 1022 frames (compare sequence length with R&S SMIQB45: 13 frames). Very long signal sequences and continuous PRBS sequences (eg PN9) like those often required for BER measurements can thus be implemented for the channel under test.
- For the enhanced channels, data fields and the transmit power control (TPC) field of the slots can be filled from data lists. This allows the use of externally precoded data or the generation of long power control profiles for the DUT.

- The code channel power of enhanced channels can be varied **in real-time** by an external control signal. This enables testing the closed-loop power control function of a mobile station for example.
- From R&S SMIQ firmware version 5.40, the four enhanced channels feature channel coding both in uplink and downlink in accordance with the reference measurement channels definition. This enables receiver and performance tests to TS 25.101, TS 25.104 and TS25.14. In addition, 12.2 kbps AMR speech to TS 25.944 is supported. From R&S SMIQ firmware 5.85 also the channel coded RACH and CPCH to TS 25.141 are supported.

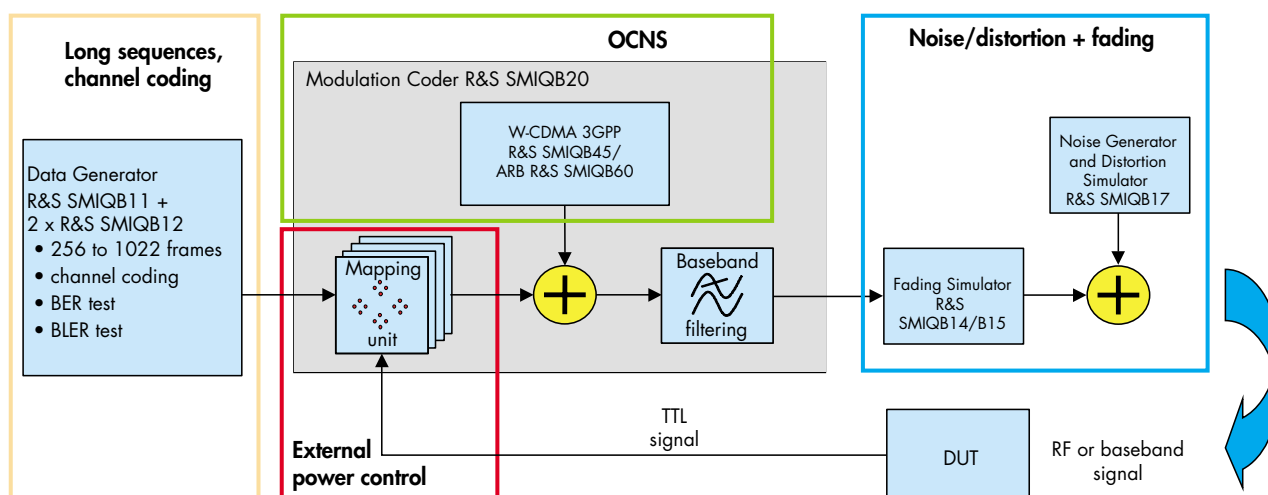

Option R&S SMIQB60: Complete test scenario with enhanced functions to digital standard WCDMA 3GPP (FDD)

# Digital modulation

- With the R&S SMIQ firmware version 5.65 or higher, the option R&S SMIQB48 makes it also possible to generate a realtime downlink broadcast channel (BCH) with an incrementing system frame number (SFN; 0 to 4094). The BCH can be combined with all reference measurement channels (RMC 12.2 kbps, 64 kbps, 144 kbps, 384 kbps) or an AMR (12.2 kbps). The sequence length of these channels (RMC and AMR) can be up to 2044 frames.

## Application examples:

- Receiver and performance tests to TS25.101
- Test of synchronization of mobile to a base-station signal combined with continuous measurement of DTCH and DCCH bit error rate and block error rate using a PN9 data sequence.
- For a realistic simulation of WCDMA scenarios, up to 64 background mobile stations can be generated in uplink in addition to the four standard mobile stations. In downlink, as many as 508 background channels (DPCHs) can be generated in addition to the four enhanced channels. 16 OCNS (orthogonal channel noise simulation) channels according to the 3GPP specification TS 25.241 can be generated upon a keystroke.
- Bit errors can be created and inserted into the data of the enhanced channels. In this way the internal BER testers of base or mobile stations can be checked for example.
- Block errors (BLERs) can be inserted into the channel-coded data.
- It is possible to generate WCDMA signals of up to 2 minutes repetition rate by combining standard channels (R&S SMIQB45) and en-

hanced channels (R&S SMIQB48) of different subsequence length.

## Arbitrary Waveform Generator R&S SMIQB60

To further enhance the versatility of the modulation coder, a dual-channel arbitrary waveform generator (ARB) with a maximum clock rate of 40 MHz is available as an option. It can store up to 512 ksamples of externally computed I/Q values.

The supplied R&S WinQSIM™ software allows the calculation of arbitrary modulation signals, for example COFDM, multicarrier and noise, and downloading them into R&S SMIQ. Together with a convenient data editor, R&S WinQSIM™ can calculate any kind of TDMA frame configuration, simulate impairments by superimposed interference signals, etc.

Note: The 512 ksample waveform memory cannot actually be compared with the relevant data of conventional ARB generators. In R&S SMIQB60, the oversampling needed for suppressing repetitive spectra by means of the analog filter

is effected automatically and in realtime by way of hardware interpolation. In this way, no waveforms created by oversampling have to be stored. With WCDMA, for example, this allows the storage of waveforms that would require 1.25 Msample output memory in the case of conventional ARB generation.

## Digital standard IS-95 with R&S SMIQ and options R&S SMIQK11 and R&S SMIQB60 (ARB)

In addition to generating IS-95 signals with option R&S SMIQB42, R&S SMIQ in conjunction with Arbitrary Waveform Generator R&S SMIQB60 now simulates CDMA signals to the North American standard IS-95A. Option R&S SMIQK11 enables IS-95 functionality under R&S WinQSIM™.

Up to eight complete base stations comprising 64 code channels each are available in forward link and up to 16 mobile stations in reverse link. The channel power can be set independently for all code channels.

Moreover, adjacent-channel power can be calculated for the first and the

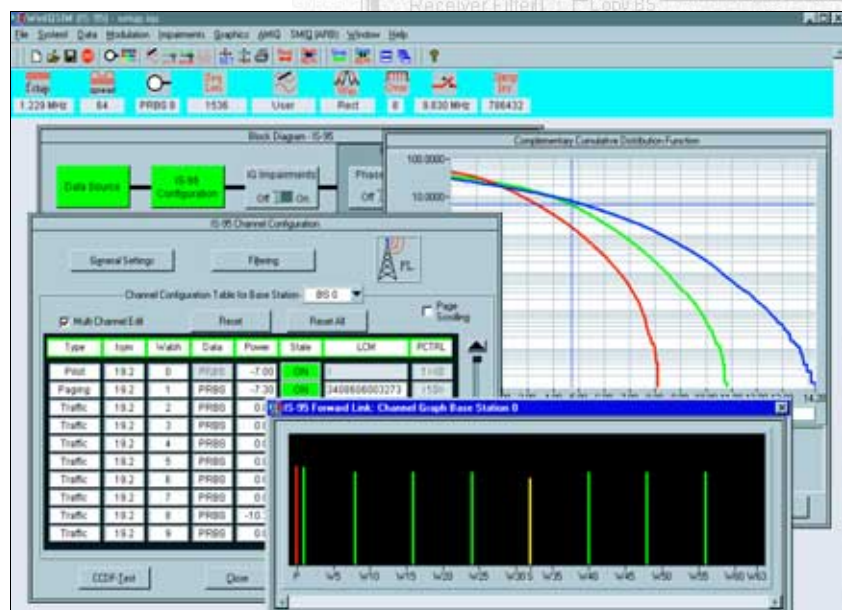

second adjacent channel and output as a spectral display. The CCDF trace too can be displayed.

**Digital standard cdma2000 with R&S SMIQ and options R&S SMIQ12 and R&S SMIQB60 (ARB)**

CDMA signals to the North American standard IS-2000 can be simulated by means of software option R&S SMIQ12 in conjunction with Arbitrary Waveform Generator R&S SMIQB60. Option R&S SMIQ12 enables cdma2000 functionality under R&S WinIQSIM™.

The modes 1X direct spread, 3X direct spread and 3X multicarrier (forward link only) are available. In forward link four base stations of max. 91 code channels can be set, in reverse link four mobile stations of max. 13 code channels each (irrespective of the radio configuration in each case).

In mode 1X, radio configurations RC 1 to RC 5 are available, in mode 3X RC 6 to RC 9.

Channel coding can be set for each base station and mobile station (selectable modes: coding off, coding complete, without interleaving, interleaving only).

R&S WinIQSIM™ enables graphic display of CCDF traces, channel graph, domain conflicts and code domain (the latter two only in forward link).

**Convenient operation with R&S WinIQSIM™ ...**

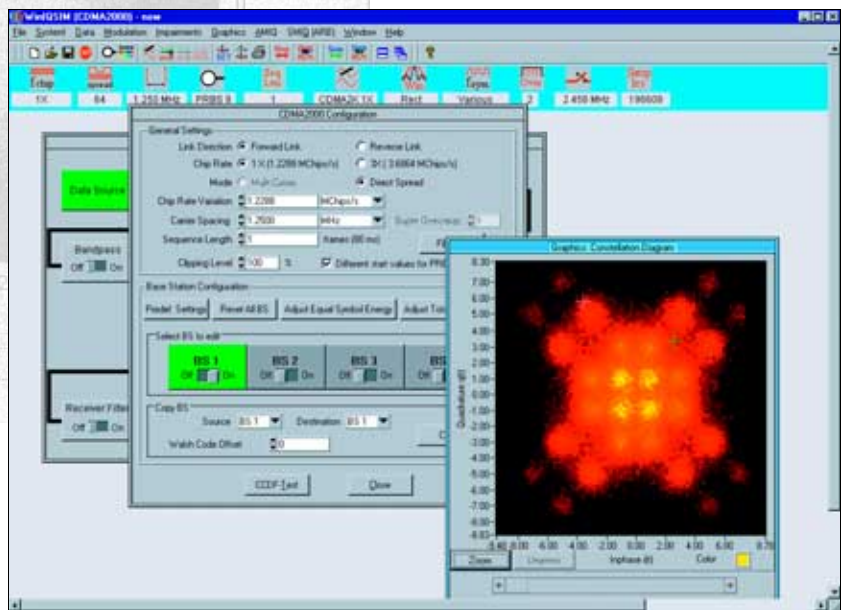
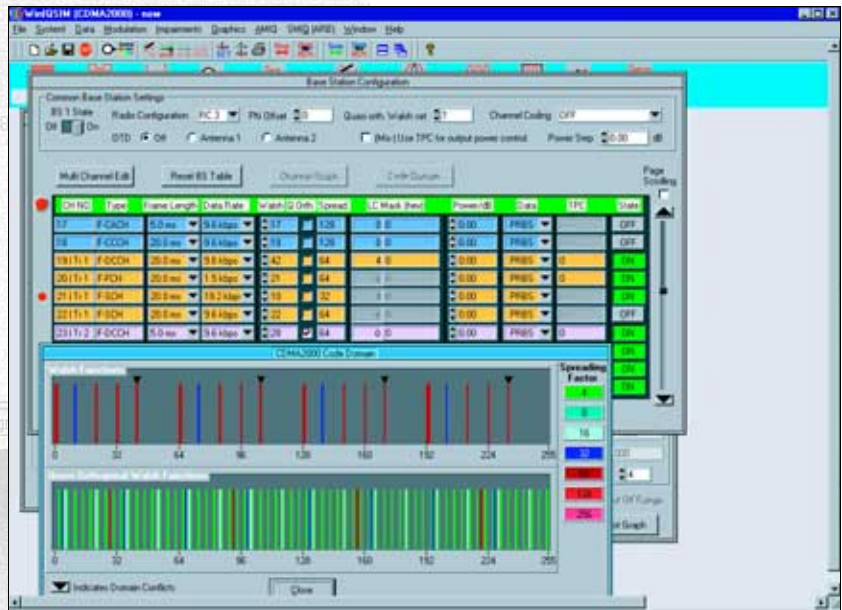

# Special options

## Fading simulation – options R&S SMIQB14/B15

With the optional fading simulator, the R&S SMIQ models are the first signal generators allowing tests that correspond to the capabilities of conventional simulators. Fading is thus no longer a matter of highly specialized measurement technology.

Fading simulation in R&S SMIQ is based on the WSSUS (wide sense stationary uncorrelated scattering) model and meets the test specifications of all main mobile radio standards, such as GSM Rec. 05.05. Both internal and external I/Q baseband signals are provided with defined multipath propagation factors through digital signal processing. Conversion to the RF with calibrated level setting is made with the available hardware of R&S SMIQ.

### 6-path fading with R&S SMIQB14

Option R&S SMIQB14 allows realistic simulation of a received signal that is composed of up to 6 propagation paths, irrespective of the selected modulation mode, with RF bandwidths of up to 14 MHz (3 dB).

Each of the 6 propagation paths can be individually parameterized in a wide range.

Rayleigh, Rice and lognormal fading profiles can be selected independently for each path. Likewise, attenuation, delay and speed can be set separately for each propagation path.

In addition to user configurations, pre-programmed settings in line with test specifications of mobile radio standards (GSM, NADC, IS-95 CDMA and TETRA) can be called at a key-stroke, which greatly facilitates operation.

## Why fading tests?

Short-time signal fading, as caused by multipath propagation, strongly affects the error rate of the received signal due to the short symbol periods in digital mobile radio

Modern digital systems overcome these problems with the aid of appropriate error control coding methods as well as algorithms for delay equalizing.

Interleaving is employed to overcome the problem of losing large parts of the messages.

Resistance to fading is an essential quality criterion of digital mobile radio systems and means a considerable competitive advantage for the manufacturer.

Tests with real-world signals using fading simulators are a must to spot the weak points in new concepts at an early stage so that appropriate modifications can be made.

Generating two correlated faded RF channels

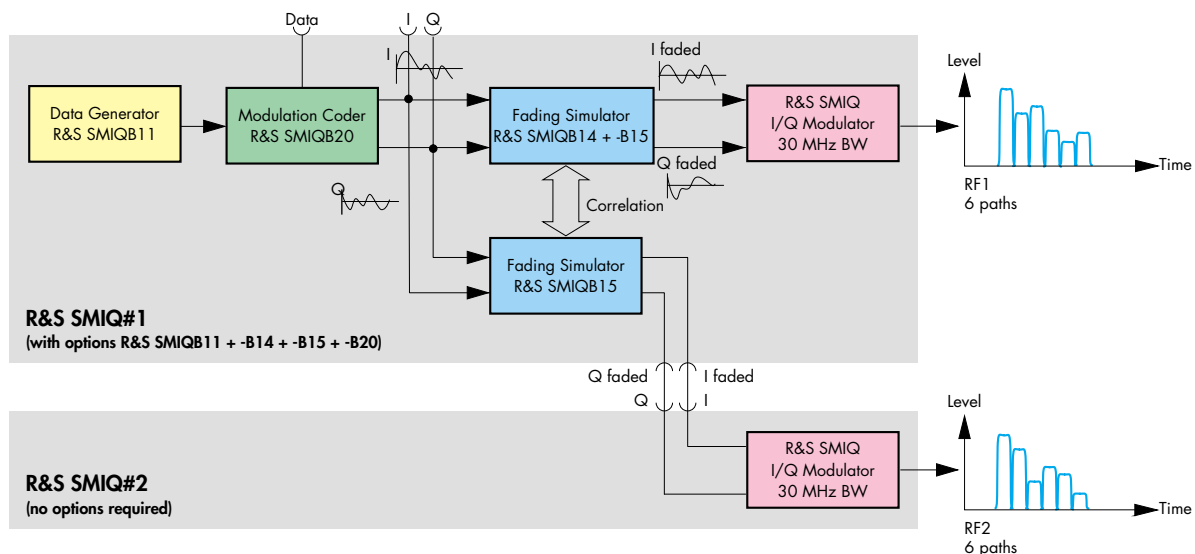



Typical Rayleigh fading profile

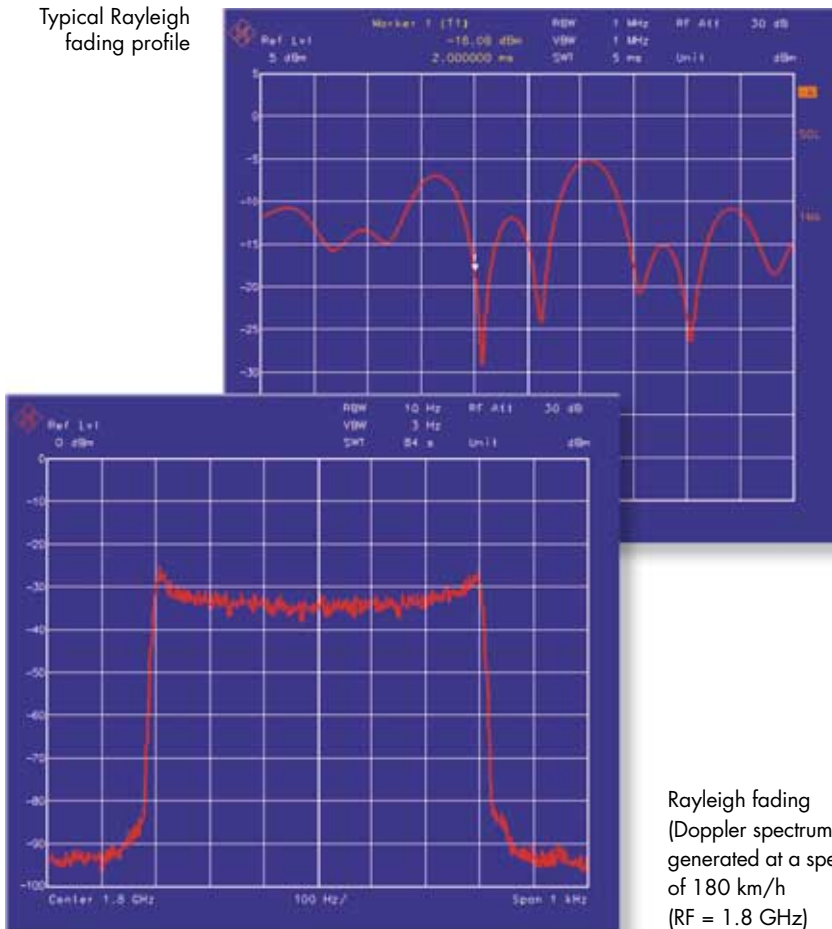

Rayleigh fading (Doppler spectrum), generated at a speed of 180 km/h (RF = 1.8 GHz)

### 12-path fading with R&S SMIQB15

Option R&S SMIQB15 provides another 6 paths for fading, which can be parameterized exactly as the first 6 paths, to give a total of 12 paths.

### 2-channel fading (6 paths per channel)

For testing base-station receivers with two separate antenna inputs (diversity), the I/Q output signals of options R&S SMIQB14 and -B15 can be separated in the (6+6)-path fading mode.

While the I/Q signals of the first fading simulator (option R&S SMIQB14) are used for driving the internal I/Q modulator, the second fading option (R&S SMIQB15) is used to feed a second vector signal generator. In this mode, the individual propagation paths of the two options can be correlated with each other one by one in pairs.

### Enhanced fading functions for WCDMA 3GPP with option R&S SMIQB49

R&S SMIQB49 extends the functionality of fading options R&S SMIQB14/B15 to include WCDMA 3GPP channel simulation. It adds three new modes to the fading simulator so that all scenarios defined in 3GPP Release 99 can be simulated:

## Advantages of the R&S SMIQ fading concept

- **Univalled price/performance ratio**

For the first time, fading in a quality corresponding to that of a high-grade simulator is available at a fraction of the costs previously involved.

- **Compact**

With this concept, neither external RF signals nor a LO signal are required to simulate fading, so that simulation is simply a compact one-box solution.

- **Versatile with calibrated output levels**

R&S SMIQ fading capability can be used without any restriction on the frequency and level range of the signal generator (-140 to -5 dBm). The user can define and store his own fading scenarios.

- **Easy to operate**

Preprogrammed settings in line with the test specifications of mobile radio standards can be recalled at a keystroke. Tests can be carried out easily and rapidly.

- In fine delay mode, fading simulator resolution is increased to 1 ns with up to four paths being available.
- In moving delay mode, two paths are simulated: for one path the delay remains constant, whereas for the other path the delay varies continuously.
- In birth-death mode, there are two paths changing delay in steps in accordance with the 3GPP channel model.

# Special options (continued)

## Noise generation and distortion simulation – R&S SMIQB17

### Real signals

A signal generator is normally used to generate as near as possible ideal signals. For testing receivers, it is however also necessary to simulate real transmitting and receiving conditions. This is exactly what option R&S SMIQB17 has been designed for.

### Noise generator

With the aid of the noise generator, an additive white Gaussian noise (AWGN) signal can be superimposed on the output signal of R&S SMIQ. The ratio of carrier power to noise power (C/N) can be varied with high resolution over a wide range. This allows for instance precise sensitivity measurement of receiver circuits with defined C/N.

### Distortion simulator

The distortion simulator allows simulation of amplitude and phase distortion (eg of a travelling wave tube in a satellite output stage). All that has to be done is to enter via the IEC/IEEE bus the input values of the AM/AM and AM/ $\phi$ M characteristics to be simulated. The complete characteristics forming the basis for nonlinear distortion of the I/Q baseband signals are calculated by means of spline interpolation. It is possible to distort I/Q signals irrespective of whether they are generated by the internal modulation coder or applied from an external source.

Digital signal processing in the baseband (I and Q signals) is used both for the generation of the AWGN signal and distortion of the output signal. This ensures high accuracy and excellent reproducibility of measurements.

### Versatile applications

Distortion simulation and additive noise can be combined with the following R&S SMIQ functions: vector modulation, digital modulation, digital standards and fading simulator.

### The method in detail

The distortion characteristics are internally represented by 2000 interpolation points which are determined by cubic spline interpolation from up to 30 input values. Several distortion characteristics can be stored under user-defined names and recalled. AM/AM and AM/ $\phi$ M distortion may also be defined by entering polynomial coefficients up to the fifth order.

Inverse polynomials can be selected for compensating the distortion of an external amplifier. The noise bandwidth can be varied in a wide range.

Constellation diagram of noisy QPSK signal

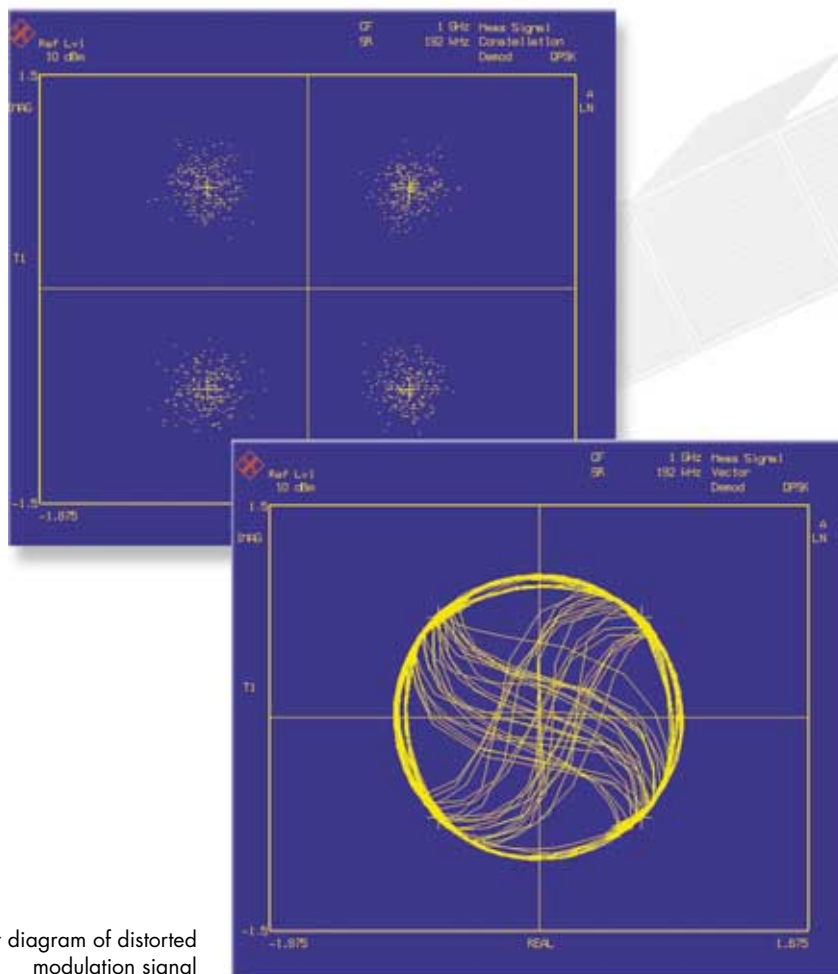

Vector diagram of distorted modulation signal

## Low ACP for IS-95 CDMA and WCDMA – R&S SMIQB47

### Challenging test requirements

Modern communications systems that are based on access methods like CDMA or WCDMA place demanding requirements on terminals and components.

For testing components (eg base-station power amplifier) that are used in such systems special test sources with outstanding characteristics regarding adjacent-channel power ratio (ACPR) are required. The measurement equipment used should cause as little interference as possible.

designed for IS-95 CDMA (1.2288 Mcps) and WCDMA (3.840 Mcps and 4.096 Mcps/8.192 Mcps respectively) and, with adjacent-channel power reduction, provides sufficient measurement margin for characterizing and testing components (eg amplifiers).

The adjacent-channel power ratio for a WCDMA signal with one DTCH (dedicated traffic channel) is typically  $-67$  dBc<sup>1)</sup>. For IS-95 CDMA the typical adjacent-channel power ratio is  $-78$  dBc<sup>2)</sup>.

Option R&S SMIQB47 can be used both with internal signals of the modulation coder (R&S SMIQB20) or with an external I/Q source (eg R&S AMIQ).

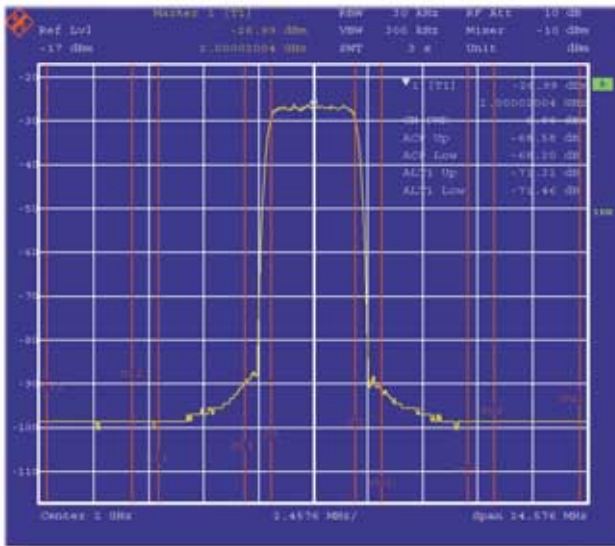

ACP measurement for a WCDMA signal with option R&S SMIQB47

### ACPR – unrivalled low

The extraordinarily low ACPR of the basic R&S SMIQ unit is made possible by the built-in high-grade I/Q modulator. In conjunction with option R&S SMIQB47 providing additional filtering in the I/Q signal path, R&S SMIQ becomes an ideal signal source suited to meet the most stringent requirements. This option has especially been

- 1) 3.84 MHz bandwidth, 5 MHz offset, 2.5 MHz I/Q filter
- 2) 9 channels, 885 kHz offset, 850 kHz I/Q filter

## Fast CPU

### Fit for production

Time is money! R&S SMIQ is equipped with a fast CPU for applications in production where complete test runs should take no more than a few seconds.

This CPU reduces the standard setting times for frequency and level to 3 ms (without switching the mechanical attenuators) to provide maximum throughput and so ensures competitiveness and economy of the production line.

## BER measurement – R&S SMIQB21

Measuring the bit error rate has become a frequently used method for the verification of digital communication systems (eg measuring the sensitivity or selectivity of receivers, subsystems and components). The retrofitable option (R&S SMIQB21) allows R&S SMIQ to be used for these BER (bit-error-rate) measurements. The device under test (DUT) has to deliver the data to be tested and the associated clock. If the DUT does not have its own clock, it can be generated by R&S SMIQ and output via bit and/or symbol clock. The built-in BER tester compares these data with the nominal data and calculates the error rate. Various standard PRBS sequences (PN9, PN15, etc) are used as nominal data. The result of the BER measurement is also available via the remote-control interface.

# Applications

## Type-approval testing of digital base and mobile stations

Mobile and base stations are complex systems, where signal generators are used for testing out system parts such as receivers, modulators and amplifiers. Due to its versatility and signal quality, R&S SMIQ is ideally suited to handle these tasks.

## Sensitivity measurements on digital receivers

Sensitivity measurements on digital receivers require high modulation quality as well as precise level setting over a wide range.

Due to the losses in automatic test systems – caused by cables and the use of power splitters, relays, attenuators,

etc – the absolute level accuracy is less important than the reproducibility of the settings. R&S SMIQ yields excellent values in this respect.

Frame structures with defined data contents for BER measurements are made available by programmed standard settings.

## Selectivity measurements on digital receivers

Low phase and broadband noise, high spurious suppression of >70 dB even with activated digital modulation as well as excellent adjacent-channel power ratios make R&S SMIQ an ideal source for selectivity measurements on digital receivers.

## Base-station transmitter test

For testing base-station transmitters, R&S SMIQ is able to supply the data signals of the internal data generator (DATA, DATA CLK, SYMB CLK) as well as the analog I/Q baseband signals.

## Testing of equalizers

The optional fading simulator for R&S SMIQ is ideal for testing the equalizers of digital receivers. While conventional fading simulators need external RF input signals, R&S SMIQ generates its own modulated RF signal. New equalizer concepts can thus be tested at a very early stage in development.

## Tolerance tests on digital systems

In addition to ideal signals, R&S SMIQ also allows the generation of signals

R&S SMIQ in TETRA simulator





Module test with  
R&S SMIQ, R&S  
AMIQ and  
Signal Analyzer  
R&S FSIQ

with defined degradations (I/Q impairments or noise and distortion with option R&S SMIQB17) as well as the variation of bit rates and filtering to determine tolerance limits and to detect potential critical spots in new systems.

#### Components tests

The high setting speed and modulation quality make R&S SMIQ supreme for use in the development and production of digital components and modules.

The high intermodulation suppression of the I/Q modulator of R&S SMIQ ensures excellent adjacent-channel power ratios of the modulated output signal for conclusive linearity measurements on amplifier components.

The high spurious suppression of >70 dB of the R&S SMIQ output signal allows accurate measurements on mixer components.

#### Development of new digital communication systems

R&S SMIQ offers all capabilities that are required for developing new digital communication systems.

Featuring a modulation bandwidth of 30 MHz (-3 dB), the I/Q modulator of R&S SMIQ is ideal for future broadband systems.

The optional modulation coder allows any digital modulation modes – from BPSK through to 256QAM – to be generated with variable data rate and baseband filtering.

With the maximum symbol rate of 18 Msymbol/s broadband digital modulation modes can be generated. Any TDMA structures can be produced with the aid of a programmable burst generator.

The modulation coder of R&S SMIQ is already equipped for future applications, eg in the field of broadband spread-spectrum systems (wireless local loop, wireless LAN).

R&S SMIQ meets already today the challenges of tomorrow's market.

## Ordering information

### Vector Signal Generator

R&S SMIQ02B (300 kHz to 2.2 GHz)	1125.5555.02
R&S SMIQ03B (300 kHz to 3.3 GHz)	1125.5555.03
R&S SMIQ04B (300 kHz to 4.4 GHz)	1125.5555.04
R&S SMIQ06B (300 kHz to 6.4 GHz)	1125.5555.06

### Accessories supplied

power cable, operating manual

### Options

Reference Oscillator OCXO	R&S SM-B1	1036.7599.02
FM/φM Modulator	R&S SM-B5	1036.8489.02
Data Generator	R&S SMIQB11	1085.4502.04
Memory Extension, 32 Mbit	R&S SMIQB12	1085.2800.04
Fading Simulator, 6 paths	R&S SMIQB14	1085.4002.02
Second Fading Simulator for 12 paths or 2 channels	R&S SMIQB15	1085.4402.02
Noise Generator and Distortion Simulator	R&S SMIQB17	1104.9000.02
RF and AF Rear Connectors	R&S SMIQB19	1085.2997.02
Modulation Coder	R&S SMIQB20	1125.5190.02
BER Measurement	R&S SMIQB21	1125.5490.02
Digital Standard IS-95 CDMA	R&S SMIQB42	1104.7936.02
Digital Standard WCDMA acc. to NTT DoCoMo 1.0, ARIB 0.0 standard	R&S SMIQB43	1104.8032.02
Digital Standard WCDMA acc. to 3GPP (FDD)	R&S SMIQB45	1104.8232.02
Low ACP for IS-95 CDMA and WCDMA	R&S SMIQB47	1125.5090.02
Modification Kit for Low ACP (factory installation only)	R&S SMIQU47	1125.5149.02
Extended Functions for WCDMA (3GPP)	R&S SMIQB48	1105.0587.02
Extended Fading Functions for WCDMA (3GPP)	R&S SMIQB49	1105.1083.02
Arbitrary Waveform Generator incl. R&S WinIQSIM™	R&S SMIQB60	1136.4390.02
TETRA T1 Simulator	R&S SMIQ-K8	1136.4290.02
Digital Standard IS-95 CDMA (for option R&S SMIQB60)	R&S SMIQK11	1105.0287.02
Digital Standard cdma2000 (for option R&S SMIQB60)	R&S SMIQK12	1105.0435.02
Digital Standard WCDMA TDD Mode (3GPP) (for option R&S SMIQB60)	R&S SMIQK13	1105.1231.02
Digital Standard TD-SCDMA (for option R&S SMIQB60)	R&S SMIQK14	1105.1383.02
OFDM Signal Generation, HIPERLAN/2 (for option R&S SMIQB60)	R&S SMIQK15	1105.1531.02
Digital Standard IEEE 802.11b (for option R&S SMIQB60)	R&S SMIQK16	1154.7700.02
Digital Standard 1xEV-DO (for option R&S SMIQB60)	R&S SMIQK17	1154.7800.02
Digital Standard IEEE 802.11a (for option R&S SMIQB60)	R&S SMIQK18	1154.7952.02

Additional hint: R&S SMIQ02B/03B (R&S SMIQ04B/06B) can be equipped with up to three (two) of the following options: R&S SMIQ-B5, R&S SMIQB14, R&S SMIQB15, R&S SMIQB17

### Application software

PC Software: Generation of data and control lists	R&S SMIQ-K1	*)
PC Software: Bluetooth signals for R&S SMIQ	R&S SMIQ-K5	*)
PC Software: User mappings and user filters for R&S SMIQ	R&S User Mod	*)

\*) available at [www.rohde-schwarz.com](http://www.rohde-schwarz.com)

### Recommended extras

19" Adapter	R&S ZZA-94	0396.4905.00
Service Kit	R&S SM-Z3	1085.2500.02
BNC Adapter for rear panel, D type connector PAR DATA	R&S SMIQ-Z5	1104.8555.02
90° Power Splitter	R&S SMIQ-Z9	1104.9580.02
Trolley for Transit Case	R&S ZZK-1	1014.0510.00
Transit Case	R&S ZZK-944	1013.9366.00
Service Manual R&S SMIQ		1085.2445.24

### Instrument upgrades

R&S SMIQ02B to R&S SMIQ03B	R&S SMIQU03	1125.5855.03
R&S SMIQ03B to R&S SMIQ04B	R&S SMIQU04	1125.5855.04
R&S SMIQ04B to R&S SMIQ06B	R&S SMIQU06	1125.5855.06

For specifications see separate data sheet (enclosed)

Certified Quality System  
**ISO 9001**  
DQS REG. NO 1954

Certified Environmental System  
**ISO 14001**  
REG. NO 1954



**ROHDE & SCHWARZ**

**USED4TEST**

Телефон: +7 (499) 685-7744

[used@used4test.ru](mailto:used@used4test.ru)

[www.used4test.ru](http://www.used4test.ru)